

AXIOM® Vector® Perimeter Trim Assembly

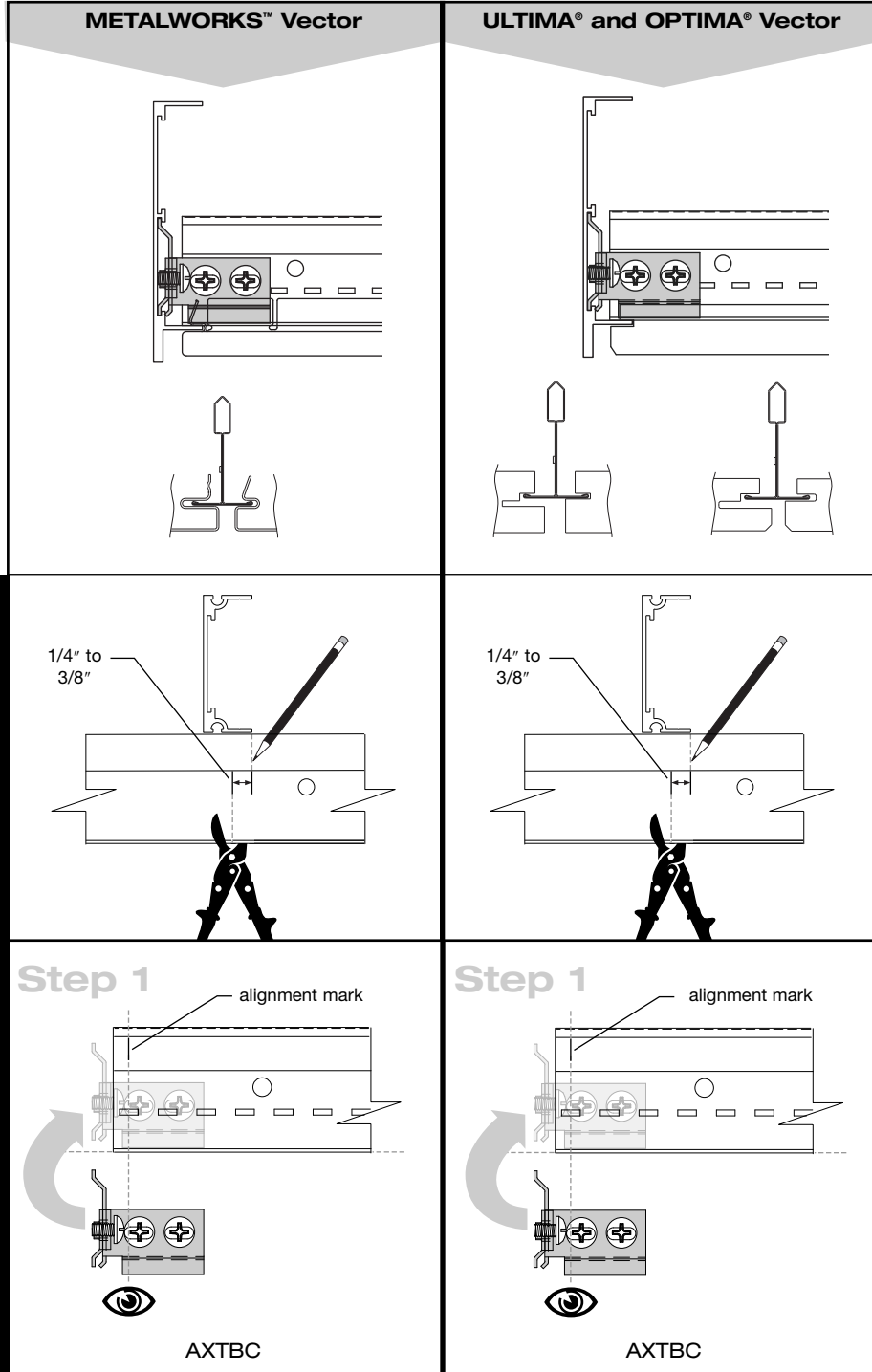

Mark Alignment and Cut Grid

T-Bar Connector Clips
(AXTBC or AXVTBC)

Rest Clip On Grid Flange
And Attach with Screws

Step 2

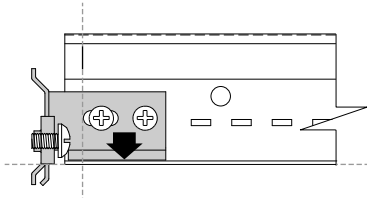

AXTBC

Step 2

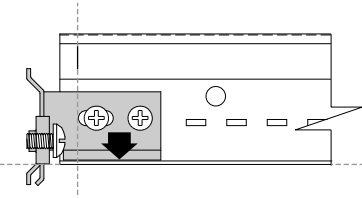

AXTBC

Place Clip into Trim Channel

Step 3

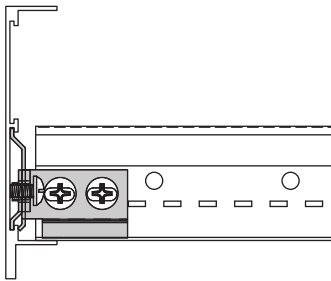

AXTBC

Step 3

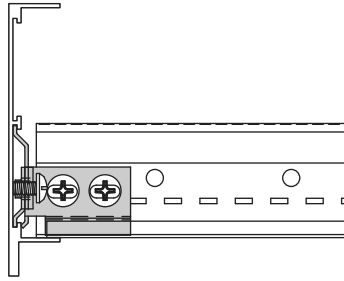

AXTBC

Splice Plate For Straight
Connections and Curved (AX4SPLICEB)

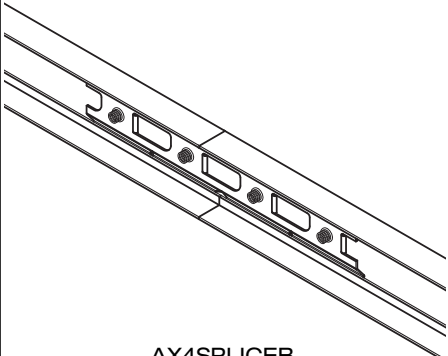

AX4SPLICEB

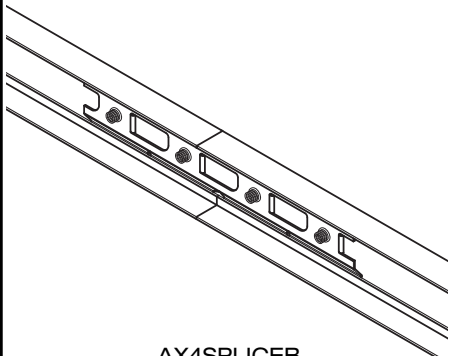

AX4SPLICEB

Splice Plate For Corner
Connections

