

## CEILING SYSTEMS

[ Between us, ideas become reality. ]®

# AXIOM® Classic Trim Installation Instructions

## 1 GENERAL

### 1.1 Description

Axiom is a perimeter trim system designed for use with most of Armstrong's suspension systems. It is available through a "quick ship" program in 10' long straight sections or as a custom fabricated assembly. Field fabrication for custom orders is limited to component assembly and minor adjustments to accommodate differences between design dimensions and actual field conditions. Quick Ship orders will require field cutting and mitering. These cuts are best made using an appropriately sized sliding compound miter saw fitted with a carbide-tipped blade designed for cutting non-ferrous metals.

These instructions are divided into four sections detailing material delivery and identification, component assembly, suspended applications and direct applied applications. Please carefully review all appropriate sections before proceeding with installation.

## 2 MATERIAL DELIVERY AND IDENTIFICATION

### (Custom Orders)

Axiom components and hardware are delivered to the job site in custom designed packaging. Locate the shop drawings and packing slip, typically packaged with the hardware, and use these as a guide to identify components as they are carefully removed from the packaging material.

Exercise appropriate care to protect the finished surfaces of the channel trim.

Each length of channel trim is marked on the inside surface, near one end. These identification marks are keyed to the shop drawings to indicate the exact location of each section in the finished assembly.

Review the shop drawings and packing slip to insure that the complete order has been delivered to the site and to familiarize you with the layout of the installation.

All curved orders for Axiom are shipped with full-sized paper template drawings. Lay your curved material on the template to make sure the curve on the template matches the Axiom product.

## 3 COMPONENT ASSEMBLY

### 3.1 Splice Plates

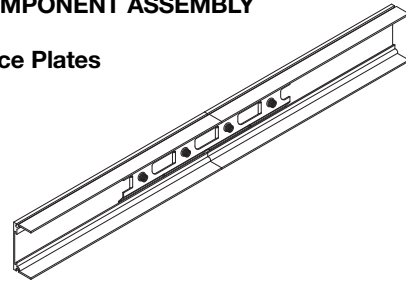

Steel splice plates are used to align and secure joints between sections of channel trim. Each joint in the 2" section height will require one splice plate; 4", 6" and 8" sections require two splice plates at each joint; 10" trim uses three splice plates per joint and the 12" high profile accepts four plates.

### 3.2 Factory Mitered Corners

Quick ship inside corners are factory mitered sections of trim that measure 12" along the edge of the flange that supports the suspension system. The unmitered ends are attached to the straight sections of Axiom trim using the AX4SPICEB (4 screw) splice plates. The mitered ends are joined using the AXSPICE (2 screw) splice plates. Outside corner posts ship pre-assembled with the splice plate (AXSPICE) already built into the product. The ends are attached to the straight sections of Axiom trim using the AXSPICE (2 screw) splice plates that are built in to the product.

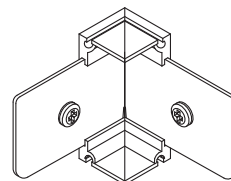

Outside Corner Post

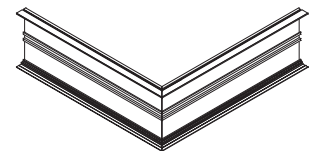

Inside Corner

AXSPICE plates are shipped flat. Hand-bend the plates as required for mitered intersections.

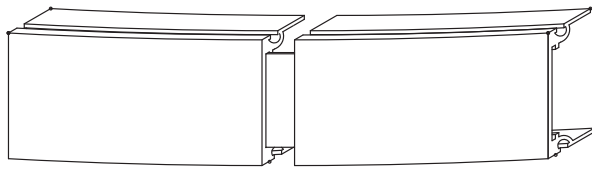

*Insert splice plate in joint  
and close to about 1/2"*

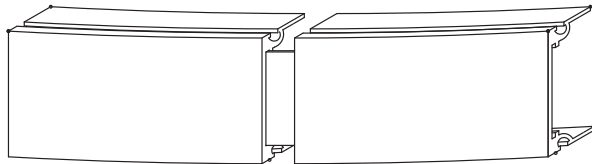

*Bend splice plate to align  
ends of channel sections*

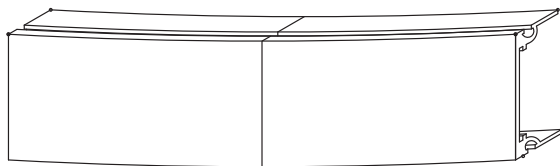

*Close joint and tighten sets screws*

Splice plates are secured to the trim sections using factory-installed setscrews.

**CAUTION:** Do not over-tighten these screws. Apply only enough force to lock the components together. Over-tightening the screws can deform the exposed face of the channel trim.

**Typical procedure**

1. Insert splices into channel trim bosses
2. Close the joint
3. Tighten screws

**3.3 T-Bar Connection Clips**

T-Bar Connection Clips are used to attach the channel trim to the supporting suspension system members. These two-piece steel clips are supplied as an assembled unit with the steel locking screw factory installed. One clip is required at each location where the grid system intersects the channel trim.

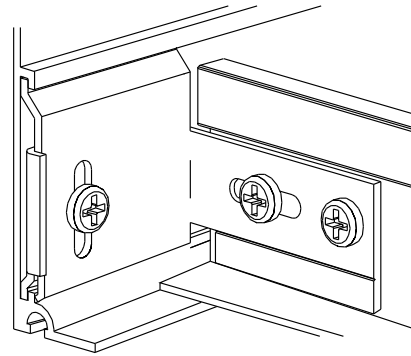

There are two versions of the T-bar Connection Clip. AXTBC is used with drywall, lay-in, tegular, concealed tile and installations of Vector panels that are all full size. AXVTBC is used with cut Vector panels.

T-Bar Connection Clips are attached to the grid members using screws supplied by the installer. Framing screws (#6 x 7/16" or 1/2" lg.) are typical. Special conditions such as open cell installations may dictate the use of alternate methods of attachment.

*See detail drawings for alignment of the connection clip with the grid member.*

**Typical procedure**

1. Cut grid to length
2. Attach clip to grid member
3. Engage clip in channel bosses and tighten locking screw

**3.4 AXIOM Alignment Clips**

AXIOM Alignment Clips, AXAC, are used to align grid members that extend beyond the lower edge of the trim. These clips should not be used in the load path for any application. These aluminum clips are supplied with a factory-installed screw that locks the clip in position.

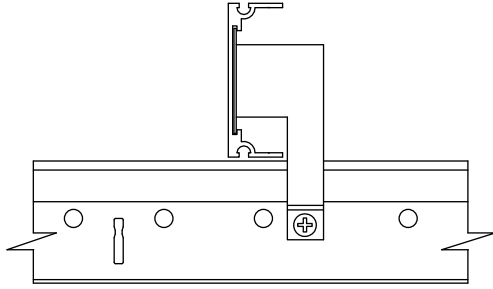

The clip is secured to the web of the grid members using a standard framing screw supplied by the installer. One clip is required at each grid/channel intersection.

**Typical Procedure**

1. Rotate hanging clips into the channel trim bosses
2. Tighten clamping screw
3. Install framing screw to attach clip to grid

Direct Load Hanging Clips, AX2HGC, are used when suspension wires must be attached directly to the trim sections. Typical installations have the wires attached to the suspension system and it supports the Axiom. The weight of the 8", 10" & 12" Axiom trim necessitate that they be supported directly to structure.

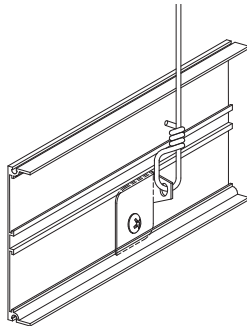

**Typical Procedure**

1. Rotate hanging clips into the channel trim bosses
2. Tighten clamping screw
3. Attach hanger wire

**3.5 Drywall Trim**

Drywall trim is used to finish the edges of 5/8" drywall panels that are applied to the bottom surface of an Axiom installation. Drywall trim sections can be factory formed to match the contour of the axiom channels to which they are applied. These components are keyed to the shop drawings to identify the location of each piece in the assembly.

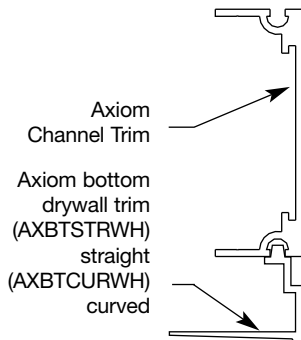

Drywall trim is fastened using standard drywall screws applied through the tapping flange of the trim into the drywall suspension system. After installation the trim is finished using standard drywall materials and techniques. Normally, the drywall and axiom trim is then painted to meet job requirements.

**Typical Procedure**

1. Install drywall suspension system and Axiom channel trim
2. Attach 5/8" drywall to the system
3. Install Axiom drywall trim
4. Tape and finish drywall
5. Paint

**3.6 Metal Panel Hold-down Clips**

Metal panel holds down clips are used to secure the cut edges of metal ceilings at the Axiom trim. Insert one clip for every foot of perimeter, or as needed to maintain contact between the panel edge and the flange of the trim.

Insert the top of the clip into the channel first. Press up to compress the clip and insert the bottom leg into the channel.

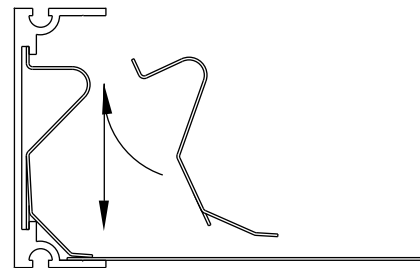

**3.7 Suspended Applications**

Suspended applications of Axiom are those in which the Axiom perimeter trim and the suspension system that supports it are installed in a manner that creates a space between the Axiom and the structure above. These installations are often referred to as "clouds" and may be as simple as a square or rectangle of free floating ceiling, or as complex as a freeform shape or symbol. Suspended Axiom applications may be purely aesthetic, or may be used to conceal overhead services or indirect lighting.

**Typical Procedure**

1. Layout and install the suspension systems according to the reflected ceiling plan.
  - 1.1. Plan your grid layout to maximize the length of cross tees that will support Axiom components.
  - 1.2. Some of these tees will have to have hanger wires attached to them. Longer tees will, in some cases, allow the wires to be located further away from the Axiom trim, and therefore, to be less visible.

2. Brace and square the suspension system.
  - 2.1. Although not absolutely necessary, this step will greatly increase the speed and accuracy of completing the remainder of the installation, and is highly recommended.
  - 2.2. The grid system can be braced diagonally to the structure above using either splayed wires, or rigid bracing members such as angles or "C" channels. In either case, install bracing in the plane of both main beams, and cross tees.
  - 2.3. Squaring can be accomplished by temporarily clamping a rigid member (main beam or wall angle) diagonally across the topside of the grid system to maintain 90° alignment of the mains and tees.
  - 2.4. An alternate method is to cut scrap grid components to fit diagonally into the ceiling grid module. When installed in pairs, these short braces are effective during layout and installation, and can be reinstalled on top of the ceiling panels to maintain alignment of the system.
  - 2.5. For small installations, it may be preferable to assemble, mark and cut the suspension system components on the floor, and then to suspend and brace the grid system.

3. Assemble and position the Axiom components on top of the suspension system.
  - 3.1. Temporarily assemble the Axiom components resting on top of the grid system. Check alignment and clamp the components in place.
  - 3.2. Mark the location where the open side of the Axiom Channel Trim rests on the grid members. This mark will be used for initial alignment of the T-Bar Connection Clip.

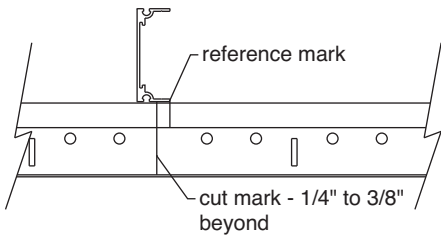

- 3.3. Make a second mark 1/4" to 3/8" closer to the face of the Axiom Channel Trim. This second mark is where the grid members will be cut. The 3/8" dimension is the maximum length that the grid member can extend into the Channel Trim. Use of the 1/4" dimension allows more adjustment during final assembly.

4. Attach the T-Bar Connection Clips.
  - 4.1. Remove the Axiom components and cut the grid members as marked.
  - 4.2. Follow these guidelines for vertical location of the clips on the web of the grid members:
    - 4.2.1. T-Bar grid that will rest on the lower flange of the Axiom Trim – use AXTBC.

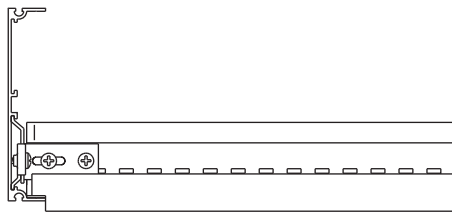
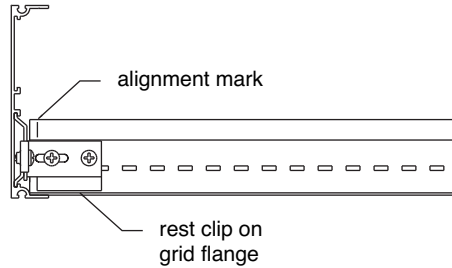

- 4.2.2. Silhouette, Interlude, Trimlok & Sonata (Systems with a 5/16" shoulder height), Tegular panels on Prelude or Superfine with the panel face resting on the trim flange & 5/8" concealed tile – use AXTBC.

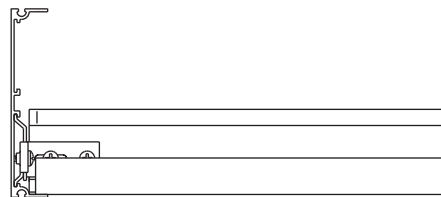
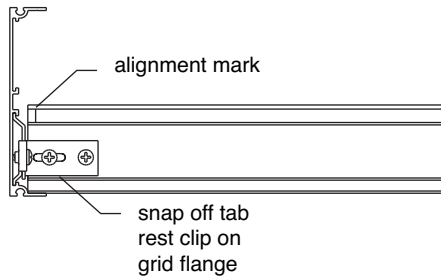

4.2.3. MetalWorks Vector (cut panels) and 3/4" concealed tile – use AX-V-TBC.

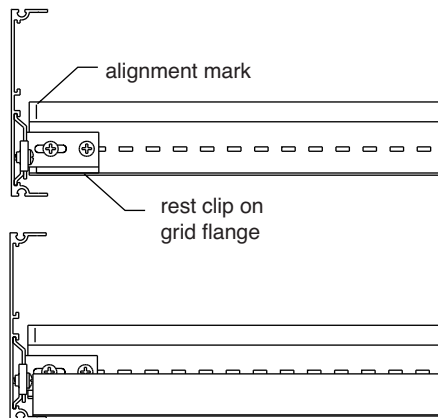

4.2.4. Ultima, Optima & Wood Vector (cut panels) – use AX V TBC.

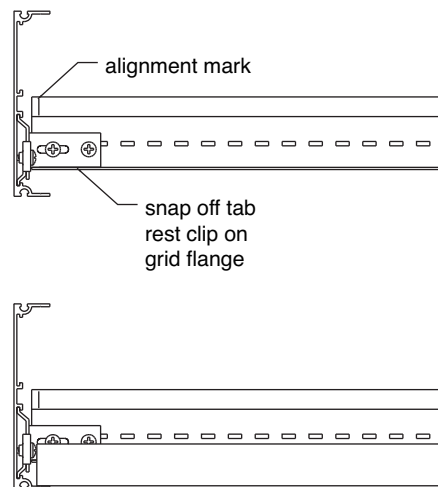

4.3. Attach the clips by aligning the end of the elongated hole with the reference mark on the grid and inserting a standard framing screw into the center of the slot.

5. Install the Axiom Channel Trim

- 5.1. Hang the sections of channel trim onto the grid system by engaging the top ear of the connection clips under the boss of the channel trim. Slide the lower leg downward to engage the lower boss on the trim and secure by tightening the locking screw.
- 5.2. Complete the installation of all channel trim sections. Install and secure the splice plates.
- 5.3. Adjust the trim as necessary to properly align the completed installation. Insert a second framing screw through the round hole in each of the connection clips.

6. Add additional hanger wires as required.

- 6.1. The manufacturer requires that Axiom system and their supporting suspension systems be installed and supported in a manner that complies to all applicable codes and standards. Typically this will require the use of #12 Ga. galvanized, soft annealed steel wire, or equivalent. Specification and approval of alternate materials should be by design professionals familiar with the project. Mechanics should exercise care in the application of hangers to minimize the visual impact on the finished installation. Wire wraps should be tight and neat, and where appropriate, the wires may be painted to blend into the background as much as possible.
- 6.2. Main beams must be supported 4' on center or by calculation based on actual ceiling weight.
- 6.3. Cross tees located on each side of a joint in the channel trim and then at 4' centers must be supported by wires located closer to the channel trim than their midpoint.
- 6.4. Installations in areas requiring seismic restraint may require wires attached to each grid member within 8" of the cut end. This practice is highly recommended for all installations. Lateral force bracing shall be consistent with locally approved standards, or as detailed in the specifications.
- 6.5. Axiom Classic 8", 10" and 12" profiles must be supported directly from the structure using two AX2HGC clips per section of trim.

7. Install ceiling panels, tile or drywall.

- 7.1. Cut and install tiles or panels using standard procedures for the specified products.
- 7.2. Treat exposed cut edges of ceiling panels as detailed in the project specifications.
- 7.3. For drywall applications, attach 5/8" gypsum panels to the suspension system per manufacturer's recommendations. **NOTE:** The Drywall Bottom Trim is designed to accommodate the full thickness of standard 5/8" panels. Layout the position of the drywall panels to prevent tapered edges from falling at the location of the Axiom trim. Trim edges by applying the Axiom Drywall Bottom trim, screwed through the face of the gypsum panel and into the supporting suspension members. Finish and paint using standard materials and techniques.

### 3.8 Brace 10" and 12" Channel Trims

The 10" and 12" high profiles may require diagonal bracing to keep the face of the trim vertical. The spacing of this bracing will be dependent on the layout of the Axiom trim. Straight sections should be braced every 4'. Radius sections will require less bracing, as the radius becomes smaller.

Fabricate the braces from T-bar grid and attach to the trim as shown below.

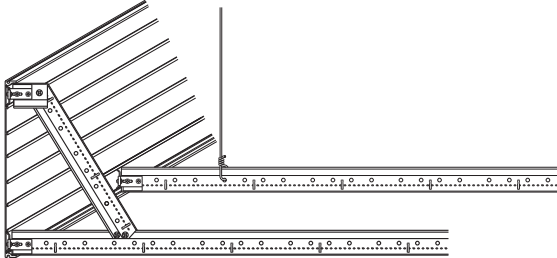

### 3.9 Direct Applied Applications

Direct applied applications of Axiom are those in which the Axiom perimeter trim components are attached by screwing directly to a drywall or acoustical ceiling suspension system. The following section details the procedures to be followed for this type of installation.

#### Typical procedure

1. Lay out the pattern on the face of the supporting system.
  - 1.1. Drywall surfaces should be taped and sanded before application of the Axiom components.
  - 1.2. Trace the pattern onto the drywall. Note that when radius sections are shown on the shop drawings the dimension is always measured from the face of the Axiom channel.
  - 1.3. Lay acoustical panels or pieces of drywall into exposed grid systems to provide enough surface area to accurately trace the pattern.

2. Attach the Channel Trim sections to the structure.
  - 2.1. Insert appropriate length screws through the top flange of the channel trim sections and into the supporting members.
  - 2.2. Install splice plates and, where required, hanging clips as the work progresses.
  - 2.3. Adjust the location of channel trim sections as required.
3. Cut and install the specified grid system to complete the installation.
  - 3.1. Prepare the T-Bar Connection Clips as described in section 4.2 for suspended applications.
  - 3.2. Install T-bar clips in the Axiom channels.
  - 3.3. Cut and install grid members and attach to T-bar clips using standard framing screws.
4. Complete the installation of ceiling panels or drywall as described in step 7 of section 3.7 for suspended applications.

## 4 FINAL DETAILING

1. Check and adjust the alignment of Axiom components and ceiling panels.
2. Clean exposed surfaces as required. Painted Axiom components may be wiped down with a mild household cleaner to remove fingerprints, oil, etc.
3. Touch up painted components as required. All painted custom Axiom shipments include a container of paint to be used for this purpose. Drywall systems are supplied with a conversion-coating factory applied. After assembly, taping and finishing the axiom components and drywall are field painted according to specification.

## MORE INFORMATION

For more information, or for an Armstrong representative, call 1 877 ARMSTRONG.

For complete technical information, detail drawings, CAD design assistance, installation information and many other technical services, call TechLine<sup>SM</sup> services at 1 877 ARMSTRONG or FAX 1 800 572 TECH.

For the latest product selection and specification data, visit [armstrong.com/axiom](http://armstrong.com/axiom).

Axiom<sup>®</sup>, Interlude, Prelude, Silhouette<sup>®</sup>, Sonata, Suprafine<sup>®</sup>, TechLine, Trimlok<sup>®</sup> and Vector are trademarks of Armstrong World Industries, Inc.

All Trademarks are owned by AWI Licensing Company

LA-295048-209

Printed in United States of America

