

## CEILING SYSTEMS

[ Between us, ideas become reality. ]®

# AXIOM® Profiled Trim Installation Instructions

## 1 GENERAL

### 1.1. Description

Profiled Axiom is a custom perimeter trim system designed for use with any of Armstrong's acoustical or drywall suspension systems. As such, field fabrication is limited to straight cuts, component assembly and minor adjustments to accommodate differences between design dimensions and actual field conditions.

These instructions are divided into four sections detailing material delivery and identification, component assembly, suspended applications and direct applied applications. Please carefully review all appropriate sections before proceeding with installation.

## 2 MATERIAL DELIVERY AND IDENTIFICATION

Profiled Axiom components and hardware are delivered to the job site in custom designed packaging. Exercise appropriate care to protect the finished surfaces of the channel trim.

Review the packing slip to insure that the complete order has been delivered to the site.

## 3 COMPONENT ASSEMBLY

### 3.1 Splice Plates and Alignment Clips

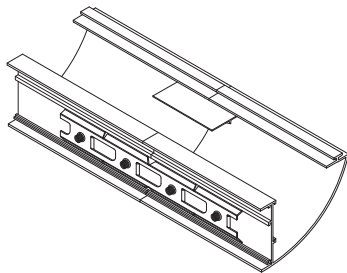

Steel splice plates (AX4SPLICEB) are used to align and secure all joints between sections of Profiled Axiom trim. Each joint will require one splice plate. If required, the top front of the extrusion may be secured using the 3" alignment clip provided with hardware. Splice plates are secured to the trim sections using factory-installed setscrews. It may be beneficial to caulk or seal the back of the joints to prevent light leaks.

### Typical procedure

1. Insert splices into channel trim bosses
2. If required, insert the 3" alignment clip into the top front boss
3. Close the joint.
4. Tighten screws

## 4 CORNER ASSEMBLY

### 4.1 Factory Welded Corners

Factory assembled corners come pre-mitered, welded and finished. The corner's length is 12" in each direction, measured along the edge of the flange that supports the grid. Corner sections are installed using AX4SPLICEB plates at each joint.

### 4.2 T-Bar Connection Clips - Acoustical Ceiling Installations

T-Bar Connection Clips are used to attach the Profiled Axiom trim to the supporting suspension system members. These two-piece steel clips are supplied as an assembled unit with the locking screw factory installed. One clip is required at each location where the grid system intersects the channel trim.

**NOTE:** For installation of T-Bar Connection Clips in drywall applications refer to the Drywall Trim Section.

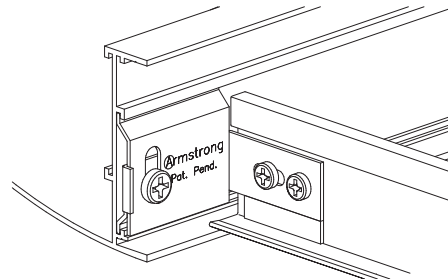

T-Bar Connection Clips are attached to the grid members using screws supplied by the installer. Framing screws (#6 x 7/16" or 1/2" lg.) are typical. Special conditions such as open cell installations may dictate the use of alternate methods of attachment.



See detail drawings, (page 3) for alignment of the connection clip with the grid member.

**Typical procedure - Acoustical Ceiling Installations**

1. Cut grid to length
2. Attach clip to grid member
3. Engage clip in lower channel bosses and tighten locking screw

**4.3 Drywall Trim**

Drywall trim is used to finish the edges of drywall panels that are applied above or within the lower section of the Profiled Axiom. Profiled Axiom drywall trim sections are factory formed to fit into the Profiled Axiom.

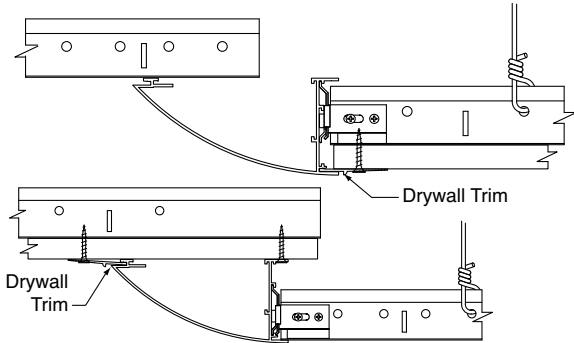

Profiled Axiom drywall trim is set in place then fastened using standard drywall screws applied through the tapping flange of the trim into the drywall suspension system.

After installation the trim is finished using standard drywall materials and techniques. Normally, the drywall and Profiled Axiom is then painted to meet job requirements.

**4.4 T-Bar Connector Clip Installation - Drywall**

**IMPORTANT NOTE:** Use only the AX-V-TBC T-Bar Connector Clip for drywall applications.

1. Cut the clip off 1/16" above the score line for application of 1/2" drywall. Cut 3/16" above the score line (half way between the score line and the bottom of the screw slots) when using 5/8" drywall.

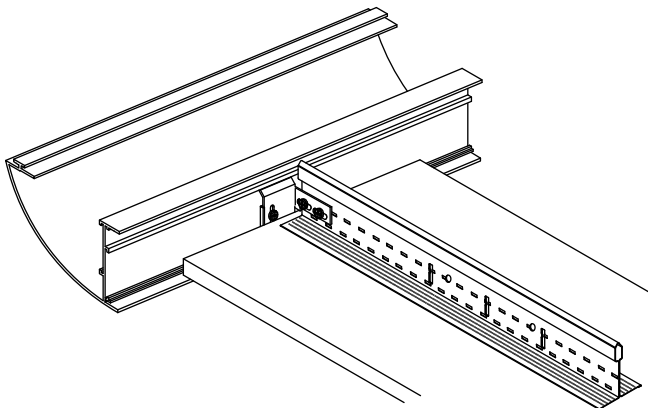

2. Attach the modified AX-V-TBC clips to the drywall grid system using two framing screws for each clip.
3. Install the Profiled Axiom trim and tighten clamping screws.

**Typical procedure - Lower Drywall Applications**

1. Install drywall suspension system and Profiled Axiom channel trim
2. Attach drywall to the system
3. Install Profiled Axiom drywall trim
4. Tape and finish drywall
5. Paint

**Typical procedure - Upper Drywall Applications**

1. Install drywall suspension system and drywall
2. Attach Profiled Axiom to the drywall suspension system by fastening through the drywall
3. Tape and finish drywall
4. Install Profiled Axiom drywall trim
5. Install lower ceiling application
6. Paint

**4.5 Suspended Applications**

Suspended applications of Axiom are those in which the Profiled Axiom perimeter trim and the suspension system that supports it are installed in a manner that creates a space between the Axiom and the structure above. These installations are often referred to as "clouds." Suspended Profiled Axiom applications may be purely aesthetic, or may be used to conceal overhead services or indirect lighting.

**Typical procedure**

1. Lay out and install the suspension system according to the reflected ceiling plan.
  - 1.1. Plan your grid layout to maximize the length of cross tees that will support Profiled Axiom components.
  - 1.2. Some of these tees will need hanger wires attached to them. Longer tees will, in some cases, allow the wires to be located further away from the Profiled Axiom trim, and therefore, to be less visible.
2. Brace and square the suspension system.
  - 2.1. Although not absolutely necessary, this step will greatly increase the speed and accuracy of completing the remainder of the installation, and is highly recommended.
  - 2.2. The grid system can be braced diagonally to the structure above using either splayed wires, or rigid bracing members such as angles or "C" channels. In either case, install bracing in the plane of both main beams, and cross tees.
  - 2.3. Squaring can be accomplished by temporarily clamping a rigid member (main beam or wall angle) diagonally across the top side of the grid system to maintain 90° alignment of the mains and tees.

- 2.4. An alternate method is to cut scrap grid components to fit diagonally into the ceiling module. When installed in pairs, these short braces are effective during layout and installation, and can be reinstalled on top of the ceiling panels to maintain alignment of the system.
- 2.5. For small installations, it may be preferable to assemble, mark and cut the suspension system components on the floor, and then to suspend and brace the grid system.

3. Assemble and position the Profiled Axiom components on top of the suspension system.

- 3.1. Temporarily assemble the Profiled Axiom components resting on top of the grid system. Check alignment and clamp the components in place.
- 3.2. Mark the location where the open side of the Profiled Axiom Channel Trim rests on the grid members. This mark will be used for initial alignment of the T-Bar Connection Clip.

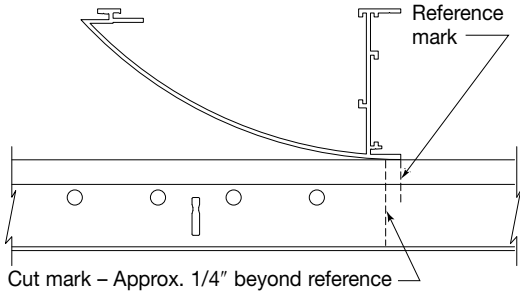

- 3.3. Make a second mark approximately 1/4" closer to the face of the Profiled Axiom Channel Trim. This second mark is where the grid members will be cut.

4. Attach the T-Bar Connection Clips

- 4.1. Remove the Profiled Axiom components and cut the grid members as marked.
- 4.2. Follow these guidelines for vertical location of the clips on the web of the grid members:

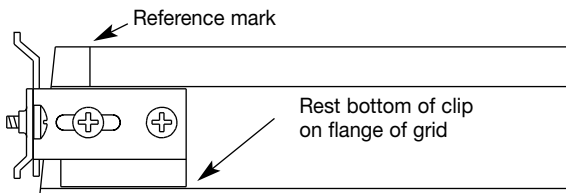

4.2.1. T-Bar grid that will rest on the lower flange of the Profiled Axiom Trim

4.2.2. Silhouette, Interlude, Sonata and Trimlok (Systems with a 5/16" shoulder height) & 5/8" concealed tile

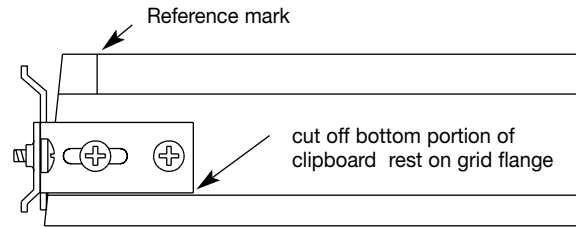

cut off the lower portion of the clip at the score line.

4.2.3. Metalworks Vector and 3/4" concealed tile

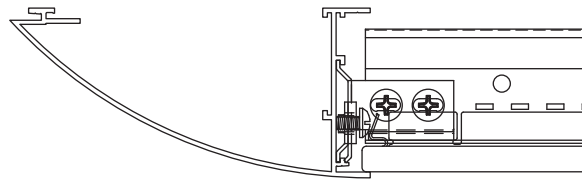

4.2.4. Ultima & Optima Vector

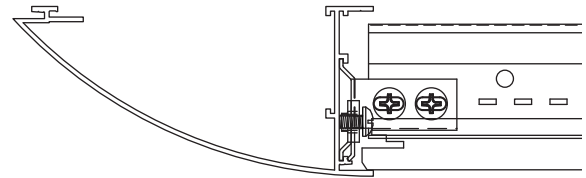

- 4.3. Attach the clips by aligning the end of the elongated hole with the reference mark on the grid and inserting a standard framing screw into the center of the slot.

5. Install the Profiled Axiom Channel Trim

- 5.1. Hang the sections of channel trim onto the grid system by engaging the top ear of the connection clips under the appropriate boss of the channel trim. Slide the back plate downward to engage the lower boss on the trim and secure by tightening the locking screw.
- 5.2. Complete the installation of all channel trim sections. Install and secure the splice plates.
- 5.3. Make adjustments as necessary to properly align the complete installation. Insert a second framing screw through the round hole in each of the connection clips.

6. Add additional hanger wires as required.
  - 6.1. The manufacturer requires that Profiled Axiom systems and their supporting suspension systems be installed and supported in a manner that complies to all applicable codes and standards. Typically this will require the use of #12 Ga. Galvanized, soft annealed steel wire, or equivalent. Specification and approval of alternate materials should be by design professionals familiar with the project. Mechanics should exercise care in the application of hangers to minimize the visual impact on the finished installation. Wire wraps should be tight and neat, and where appropriate, the wires may be painted to blend into the background as much as possible.
  - 6.2. Main beams must be supported 4' on center or by calculation based on actual ceiling weight.
  - 6.3. Cross tees located on each side of a joint in the channel trim and then at 4' centers must be supported by wires located closer to the channel trim than their midpoint.
  - 6.4. Installations in areas requiring seismic restraint may require wires attached to each grid member within 8" of the cut end. This practice is highly recommended for all installations. Lateral force bracing shall be consistent with locally approved standards, or as detailed in the specifications.
  - 6.5. Each section of trim must also be supported to the structure by two hanger wires connected to AX2HGC Hanging Clips.
7. Install ceiling panels, tile or drywall
  - 7.1. Cut and install tiles or panels using standard procedures for the specified products.
  - 7.2. Treat exposed cut edges of ceiling panels as detailed in the project specifications.
  - 7.3. For drywall applications, attach gypsum panels to the suspension system per manufacturer's recommendations.

**NOTE:** *The recommendations made on page three position the Profiled Axiom Drywall Trim to accommodate the full thickness of standard 1/2" or 5/8" panels. Lay out the position of the drywall panels to prevent tapered edges from falling at the location of the Profiled Axiom trim. Trim edges by applying the Profiled Axiom Drywall trim, screwed through the face of the gypsum panel and into the supporting suspension members. Finish and paint using standard materials and techniques.*

#### 4.6 Direct Applied Applications

Direct applied applications of Profiled Axiom are those in which the Profiled Axiom perimeter trim components are attached by screwing directly to a drywall or acoustical

ceiling suspension system. The following section details the procedures to be followed for this type of installation.

#### Typical procedure

1. Lay out the pattern on the face of the supporting system.
  - 1.1. Drywall surfaces should be taped and sanded before application of the Axiom components.
  - 1.2. Trace the pattern onto the drywall. Note that the dimensions for factory cut trim are always measured from the outer most face or edge of the Profiled Axiom channel.
  - 1.3. Lay acoustical panels or pieces of drywall into exposed grid systems to provide enough surface area to accurately trace the pattern.
2. Attach the Channel Trim sections to the structure.
  - 2.1. Install splice plates and alignment clips as the work progresses.
  - 2.2. Adjust the location of channel trim sections as required.
  - 2.3. On drywall installations insert drywall trim into the top boss in the Profile Axiom. Insert appropriate length screws through the drywall trim and into the supporting members.
3. Cut and install the specified lower grid system to complete the installation.
  - 3.1. Prepare the T-Bar Connection Clips as described in section 4.4 for suspended applications.
  - 3.2. Install T-bar clips in the Profiled Axiom channels.
  - 3.3. Cut and install grid members and attach to T-bar clips using standard framing screws.
4. Complete the installation of ceiling panels or drywall as described in step 7 of section 4.5 for suspended applications.

#### Typical procedure

1. Check and adjust the alignment of Profiled Axiom components and ceiling panels.
2. Clean exposed surfaces as required. Painted Profiled Axiom components may be wiped down with a mild household cleaner to remove fingerprints, oil, etc.
3. Touch up painted components as required. After assembly, taping and finishing the Profiled Axiom components and drywall are field painted according to specification.
4. For light cove applications a white latex chalk should be applied to the inside of all seams to prevent light leaks through the seams.

## MORE INFORMATION

For more information, or for an Armstrong representative, call 1 877 ARMSTRONG.

For complete technical information, detail drawings, CAD design assistance, installation information and many other technical services, call TechLine™ services at 1 877 ARMSTRONG or FAX 1 800 572 TECH.

For the latest product selection and specification data, visit [armstrong.com/axiom](http://armstrong.com/axiom).

Axiom®, Interlude, Prelude, Silhouette®, Sonata, Suprafine®, TechLine, Trimlok® and Vector are trademarks of Armstrong World Industries, Inc.

